

- CRT DISPLAY MAGNETICS.
- STANDARD LINEARITY COIL, < 3.0A PEAK.
- HORIZONTAL LINEARITY COILS ARE USED TO CORRECT THE IMBALANCE BETWEEN THE RIGHT AND LEFT-HANDED SIDES OF THE CRT PICTURE SO THAT THEY ARE THE SAME SIZE.
- THESE MAGNETICALLY BIASED LINEARITY COILS ARE FINGERTIP ADJUSTABLE TO COMPENSATE FOR STANDARD MANUFACTURED MATERIAL TOLERANCES OF OTHER COMPONENTS IN YOUR DISPLAY CIRCUIT.
- TYPICAL UNITS CAN BE ADJUSTED TO COVER THE RANGES INDICATED ON THE GRAPHS BELOW.
- THESE UNITS MEET OR EXCEED ALL FLAMMABILITY REQUIREMENTS OF UL94V-2.
- CUSTOM UNITS ARE ALSO AVAILABLE FOR YOUR SPECIFIC DISPLAY CIRCUIT REQUIREMENTS.

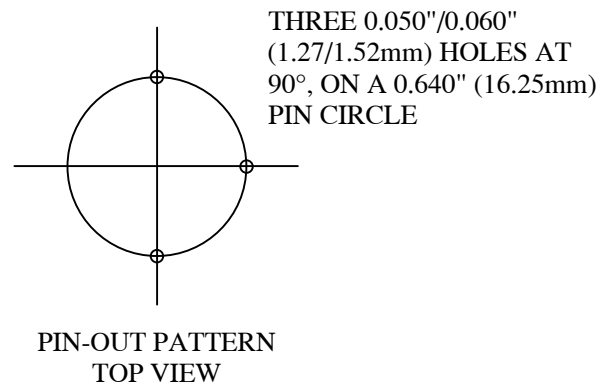
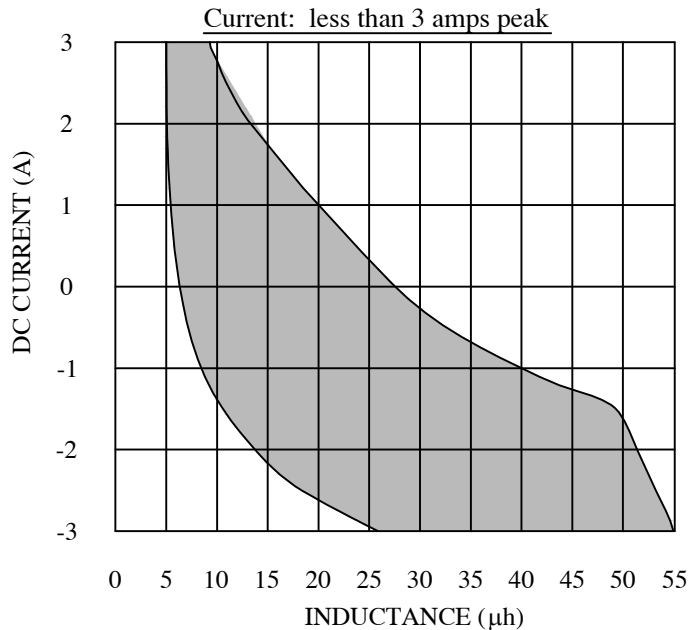
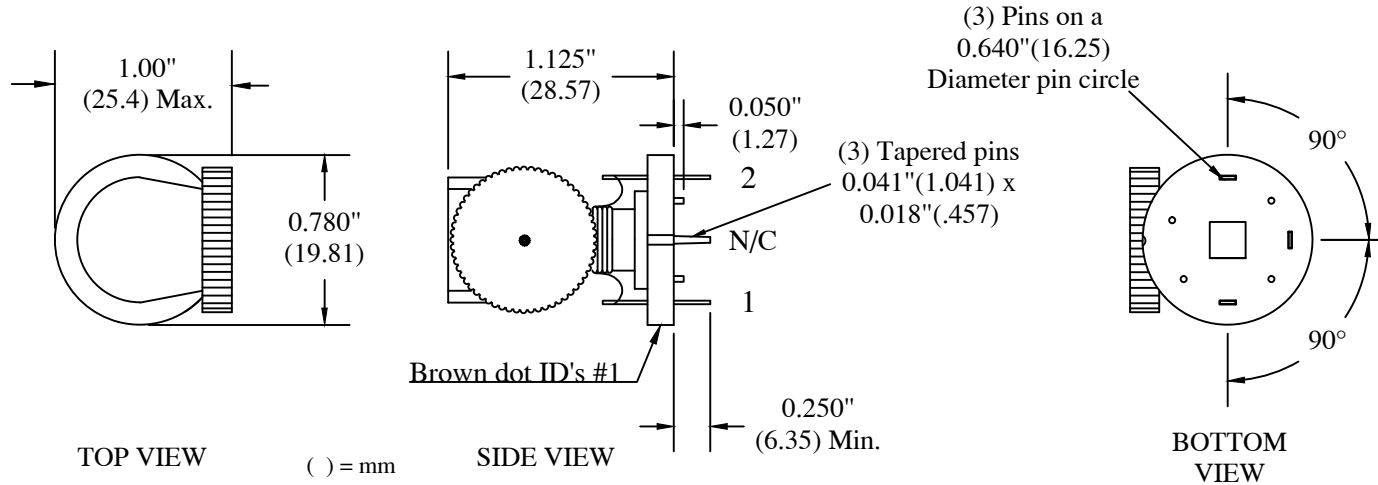

DRAWING
3511

Notes

ALL DIMENSIONS ARE INCHES
AND ARE FOR REFERENCE ONLY
() = mm

PREM
MAGNETICS INCORPORATED
3521 N. CHAPEL HILL RD.
JOHNSBURG, IL 60051

PREM Part
3511
MECHANICAL/
ELECTRICAL

Approved: TJK
Scale: None
Date: 09/09/2015